

Overview

- M8, male, A-coded, 3-poles; PUR, 30 cm; M8, female, A-coded, 3-poles
- Dragchain capable; suitable for robotics ± 360 °/m
- Head A: IP65, IP66K, IP67; Head B: IP65, IP66K, IP67
- Cable: good resistance against chemicals, flames, oils
- Halogen free



Technical data

Side A

| | |
|------------------------------|--|
| Head A: Connection | M8 |
| Head A: Angle cable outlet | 0° |
| Head A: Gender | Male |
| Head A: Coding | A |
| Head A: No. of poles | 3 |
| Head A: LED | No |
| Head A: Width across flats | AF9 |
| Head A: Tightening torque | 0.4 Nm |
| Head A: Knurled nut material | Brass, Ni plated, surface Safe-Cover silvergray matt |
| Head A: Body color | Black |
| Labeling sleeve side A | Yes |

Side B

| | |
|------------------------------|--|
| Head B: Connection | M8 |
| Head B: Angle cable outlet | 90° |
| Head B: Gender | Female |
| Head B: Coding | A |
| Head B: No. of poles | 3 |
| Head B: LED | No |
| Head B: Width across flats | AF9 |
| Head B: Tightening torque | 0.4 Nm |
| Head B: Knurled nut material | Zinc-pressure die casting, Ni plated, surface Safe-Cover silvergray matt |
| Head B: Body color | Black |
| Head B: Gasket material | FKM |
| Labeling sleeve side B | Yes |

Cables

| | |
|---------------------------|----------------------|
| Cable length | 30 cm |
| Length tolerance | + 3 cm |
| Shielded | No |
| Conductor structure | 42 × 0.1 mm |
| AWG | 22 |
| External sheath: Material | PUR |
| External sheath: Color | Yellow |
| Cable diameter | 4.3 mm ± 5% |
| Wire cross section | 0.34 mm ² |

Electrical data

| | |
|-------------------|------------------------|
| Operating voltage | max. 50 V AC / 60 V DC |
|-------------------|------------------------|

Electrical data

| | |
|------------------------------------|--------------|
| Operating voltage (only UL listed) | 30 V AC/DC |
| Nominal voltage | 300 V |
| Contact resistance | max. 30 mOhm |
| Operating current per contact | max. 4 A |

Mechanical data

| | |
|---------------------------------|--------------------------|
| Head A: Degree of protection | IP65, IP66K, IP67 |
| Head B: Degree of protection | IP65, IP66K, IP67 |
| Bending radius (mobile) | min. 10 × outer diameter |
| Bending radius (fixed) | min. 5 × outer diameter |
| No. of bending cycles (C-track) | approx. 10000000 Cycles |
| Torsion speed | max. 35 cycles/min |
| Torsion stress in ° | ± 360 °/m |
| No. of torsion cycles | approx. 1000000 Cycles |
| Acceleration (C-track) | max. 5 m/s ² |
| Travel speed (C-track) | max. 3.3 m/s |

Environmental conditions

| | |
|-----------------------------------|---|
| Temperature range (mobile) | - 25 ...+ 80 °C |
| Temperature range (fixed) | - 25 ...+ 80 °C |
| Cable: Temperature range (fixed) | - 40 ...+ 80 °C |
| Dragchain capable | Yes |
| Head A: Chemical resistance | No |
| Head A: Flame resistance | HB (UL 94) |
| Head A: Oil resistance | ASTM 1 oil, mineral oils, limited to hydraulic oils |
| Head A: Acid and alkali resistant | No |
| Head A: Pollution degree | 3 |
| Head B: Flame resistance | HB (UL 94) |
| Head B: Oil resistance | ASTM 1 oil, mineral oils, limited to hydraulic oils |
| Head B: Acid and alkali resistant | No |
| Head B: Pollution degree | 3 |

Technical data

Environmental conditions

| | |
|----------------------------|---|
| Cable: Chemical resistance | Good (DIN EN 60811-404) |
| Cable: Flame resistance | Conform UL 1581 §1090 (H), CSA FT2, IEC 60332-2-2 |
| Cable: Oil resistance | Good (DIN EN 60811-404) |

Environmental conditions

| | |
|----------------------|-----|
| Cable: Silicone-free | Yes |
|----------------------|-----|

Commercial data

| | |
|--------|----------|
| Eclass | 27060311 |
|--------|----------|

Side A

Technical drawing

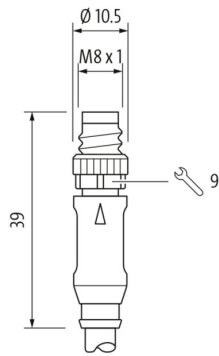

Side B

Technical drawing

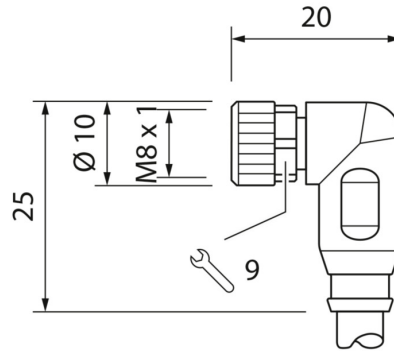

Coding

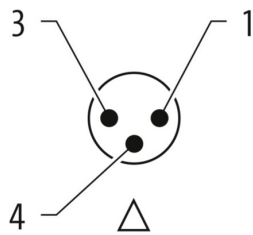

Coding

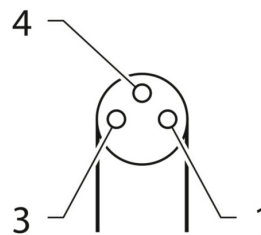

Connection diagram

