

ESW 31AH0500

Connector M8, 4 pin, angular, 5 m

Article number: 10132816

Overview

- Connector unshielded
- 3 and 4 pin versions
- Cable coating PUR
- Halogen-free
- Suitable for flexible cable carriers
- UL listed, number E315836



Picture similar

Technical data

General data

Type (head 1)	Angled
Dimension (head 1)	M8
Length	5 m
Material cable jacket	PUR halogen-free
Number of positions	4 pins
Shielding	Unshielded
Protection class	IP 65/67/68

General data

Usage	Connecting cable for Connector type M8
-------	--

General data

Connection type (head 1)	Connector female
Dimension (head 1)	M8
Type (head 1)	Angled
Connection type (head 2)	Free cable end
Particular characteristics	Suitable for flexible cable carriers
Shielding	Unshielded
Material cable jacket	PUR halogen-free
Length	5 m
Number of positions	4 pins
Protection class	IP 65/67/68

Dimension drawing

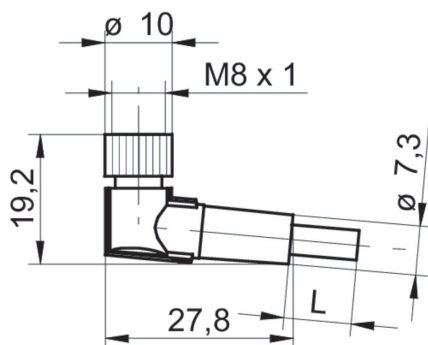

Pin assignment

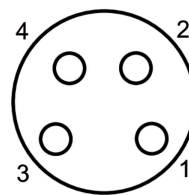

- 1 = BN
- 2 = WH
- 3 = BU
- 4 = BK